



TORRE MELINA

— A GRAN MELIÀ HOTEL —
BARCELONA

- OPENING JANUARY 2024 -

BARCELONA



SAGRADA
FAMÍLIA



TORRE
GLORIES

Hotel Barcelona Condal Mar
AFFILIATED
BY MELIÀ

MELIÀ
SKY
BARCELONA



LA PEDRERA



CASA
BATLLÓ

ME
BARCELONA



PLAÇA
CATALUNYA

RAMBLA



MELIÀ
SARRIÀ
BARCELONA



SANTS TRAIN
STATION

PALAU CONGRESSOS
CATALUNYA

TORRE MELINA
A GRAN MELIÀ HOTEL
BARCELONA



CAMP
NOU

COLUMBUS
MONUMENT



INNSIDE by Melià
Barcelona Apolo



HARBOUR

Hotel Barcelona Aeropuerto

AFFILIATED
BY MELIÀ

AIRPORT



MONTJUIC

STRUCTURE

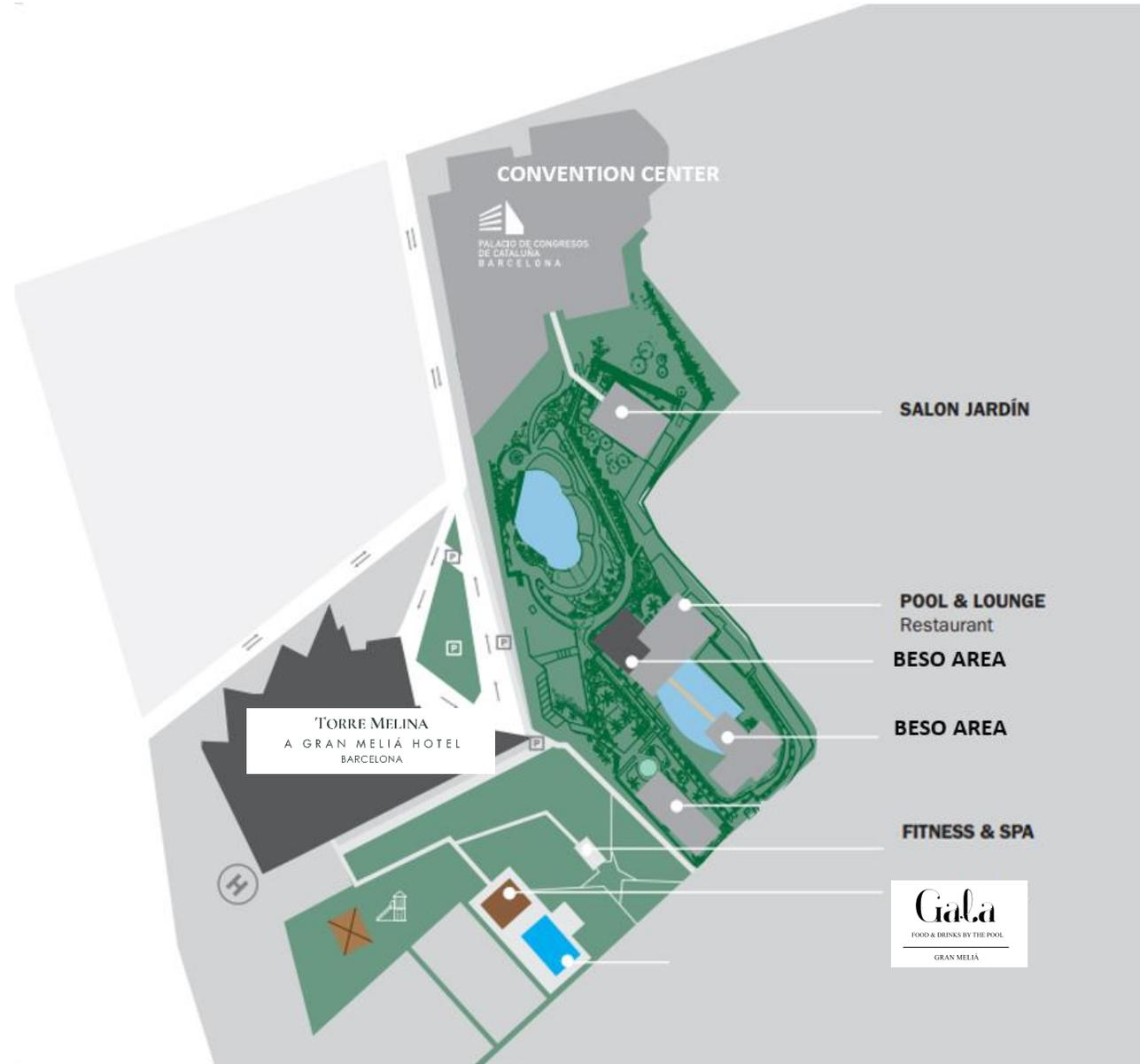



‘A BOLD NEW VISION OF WHAT
IT MEANS TO LIVE WELL, AWAY
FROM HOME’



THE BRAND

Gran Meliá evokes the essence of Spanish culture: simple pleasures, connection with the land, respect for the things done well and elegance in every detail.



BARCELONA

Barcelona is one of the most avant-garde cities worldwide. Its history, intense cultural life, architecture and creativity turns it into a reference for global trends.



*'An urban resort that flies
over Barcelona'*

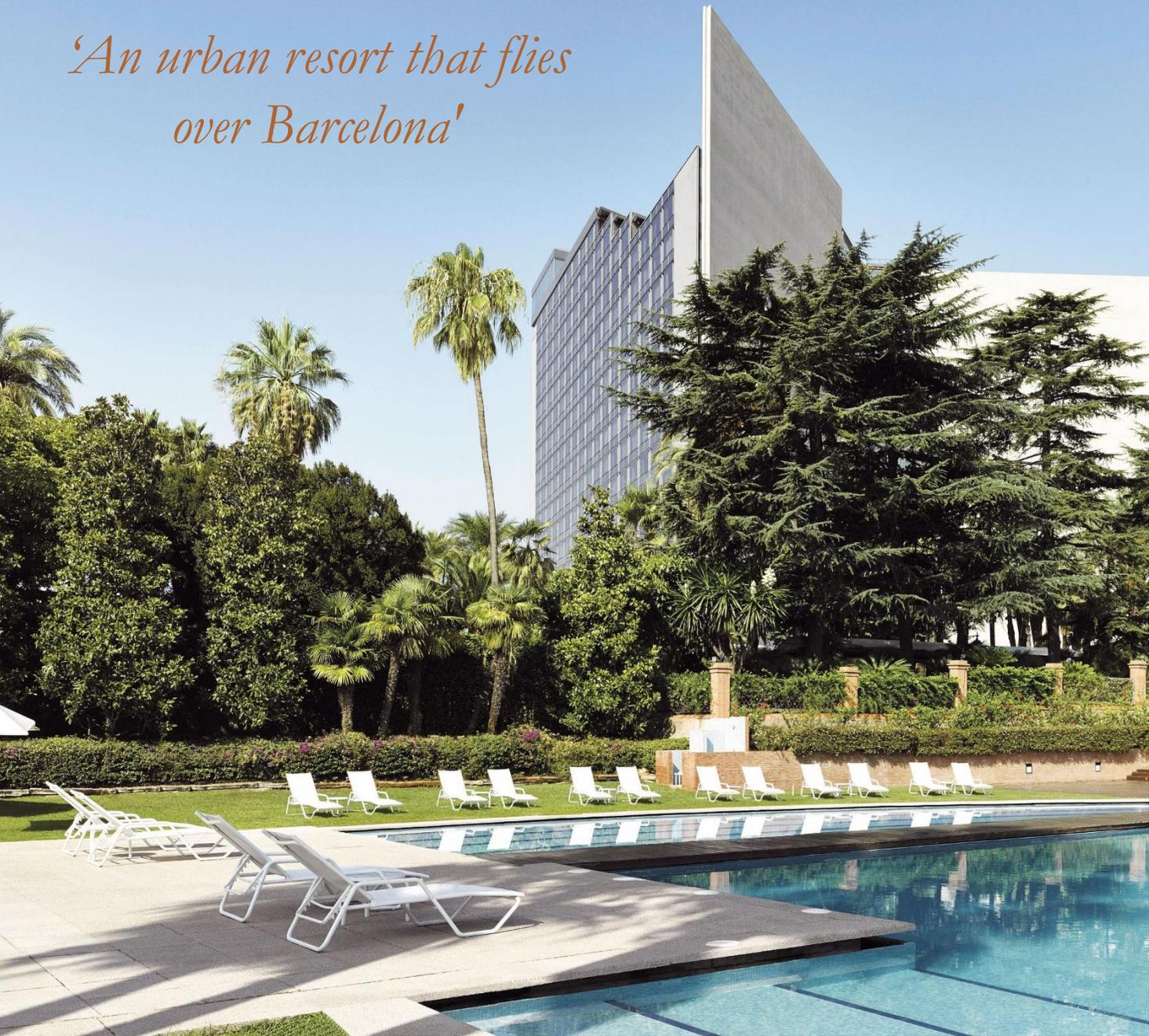

TORRE MELINA

— A GRAN MELIÀ HOTEL —
BARCELONA

Torre Melina defines itself as an urban hotel with a resort feel, as an escape from the hustle and bustle of the city, offering breathtaking views, top-quality facilities and a convenient location in the upper part of Diagonal Avenue.

It was inaugurated in 1992 for the Olympic Games by the Catalan architect Carlos Ferrater, and its based on the grounds of the ancient “Masía Torre Melina”, which dates back to the 12th century.

The hotel proudly preserves fragments of its iconic modernist centuries-old gardens with a size of 25.000sqm and which now stand as a testament to its timeless beauty.

The complex features 391 rooms and suites and a bunch of meeting spaces for indoor and outdoor events.



Rooms & Suites



ROOM TYPOLOGIES



Deluxe Room
Premier Room
Supreme Room
Red Level Supreme Room
Red Level Suite
Red Level Suite Long Stay
Red Level Master Suite
Red Level Master Suite Long Stay
Red Level Presidential Suite
Red Level Penthouse Suite





DELUXE AND PREMIER ROOMS

- 30 sqm size and views to the mountain and the Real Club de Polo de Barcelona
- Equipped with a 42" plasma screen, a work table and a sofa.
- Rooms with two Queens or one King size Bed
- Deluxe Rooms are located from 1st to 5th floor.
- Premier Rooms are located from 6th to 9th floor.



SUPREME ROOMS

- 40 sqm size and views to the Real Club de Polo de Barcelona.
- Equipped with a 42" plasma screen, a work table and a sofa.
- King size bed.
- Supreme Rooms are located from 1st to 5th floor, at the corner of the building.
- Supreme Rooms with Views are located from 6th to 9th floor:





Red Level SUPREME ROOMS



- 30sqm Size and views to the city and the mountains.
- Equipped with a 42" plasma screen, a work table and a sofa.
- King size bed.
- Located from the 10th to the 15th floor.
- **Red Level Attribute:** Exclusive access to the Red Level Private Lounge.

Red Level SUITE

- 60 sqm size and views to the city.
- Spacious separated living room, two bathrooms and a connected bedroom.
- Equipped with a 50" plasma screen , a work table, a sofa bed and a coffee maker.
- Located from the 14th to 15th floor.
- **Red Level Attribute:** Exclusive access to the Red Level Private Lounge.
- **A long stay service is available:** equipped with a kitchenette to enhance your accommodation.



Red Level MASTER SUITE

- 100 sqm size and views to the Real Club de Polo de Barcelona and the city.
- Spacious separate living room, two bathrooms and foyer.
- Equipped with a 50" plasma screen , a work table, a sofa bed and a coffee maker.
- Located from 1st to 9th floor.
- **Red Level Attribute:** Exclusive access to the Red Level Private Lounge.
- **A long stay service is available:** equipped with a kitchenette to enhance your accommodation.

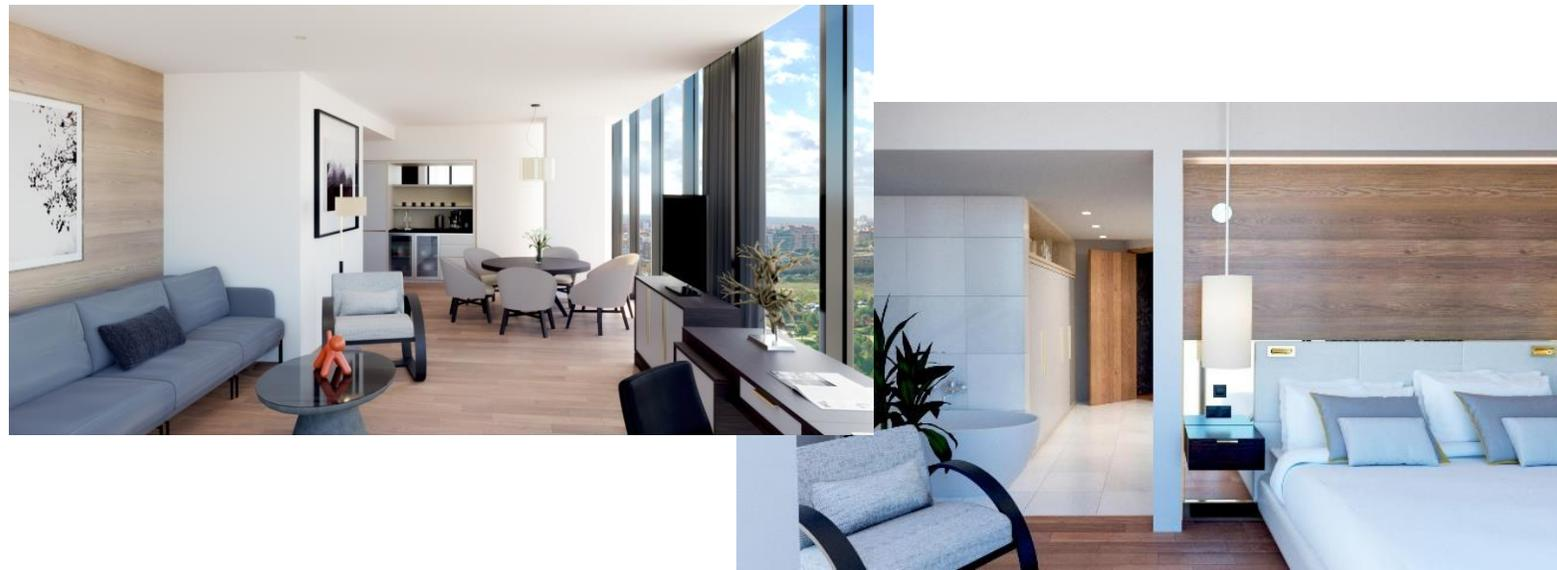

Red Level
PRESIDENTIAL SUITE



Red Level PRESIDENTIAL SUITE

- 115 sqm size and views to the city.
- Spacious separate living room, two bathrooms and foyer.
- Equipped with a 50" plasma screen , a work table, a sofa bed and a coffee maker.
- Located on 14th floor.
- **Red Level Attribute:** Exclusive access to the Red Level Private Lounge.
- **A long stay service is available:** equipped with a kitchenette to enhance your accommodation.



Red Level PENTHOUSE SUITE

A spectacular suite of 300m² on 3 floors, located in the highest part of the hotel and designed to offer a stay full of exclusivity, comfort and privacy. It's composed by two bedrooms, dining room, living room and terrace with private pool.

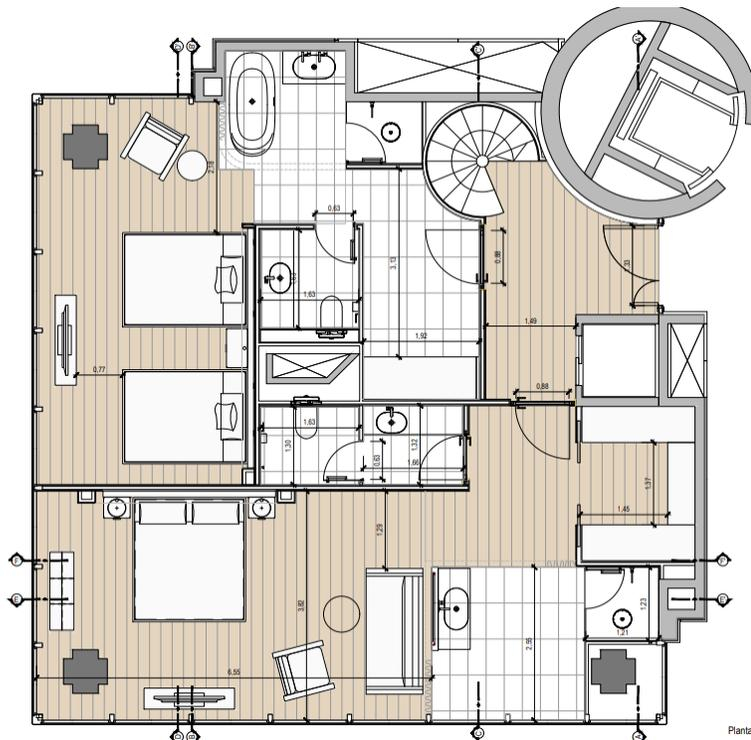

14th FLOOR

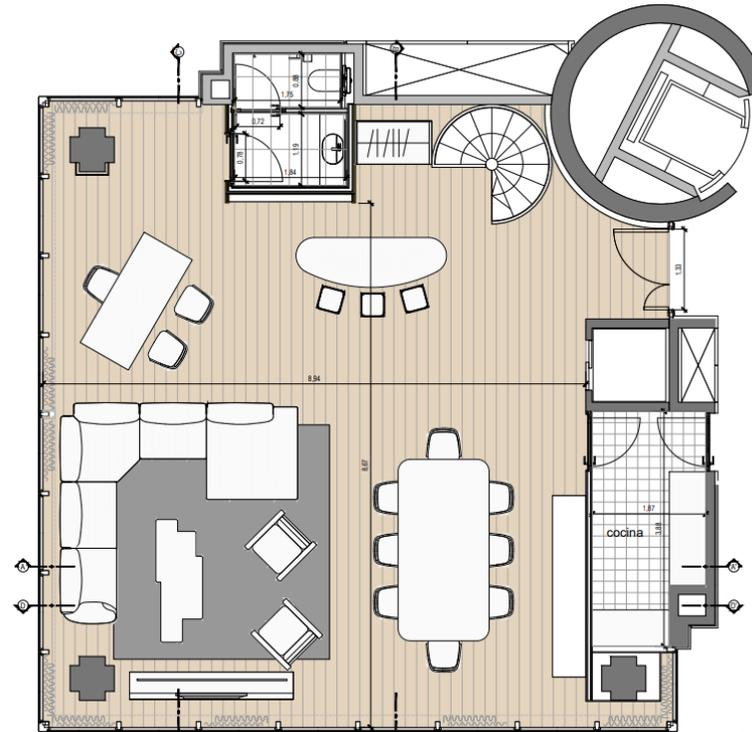

15th FLOOR

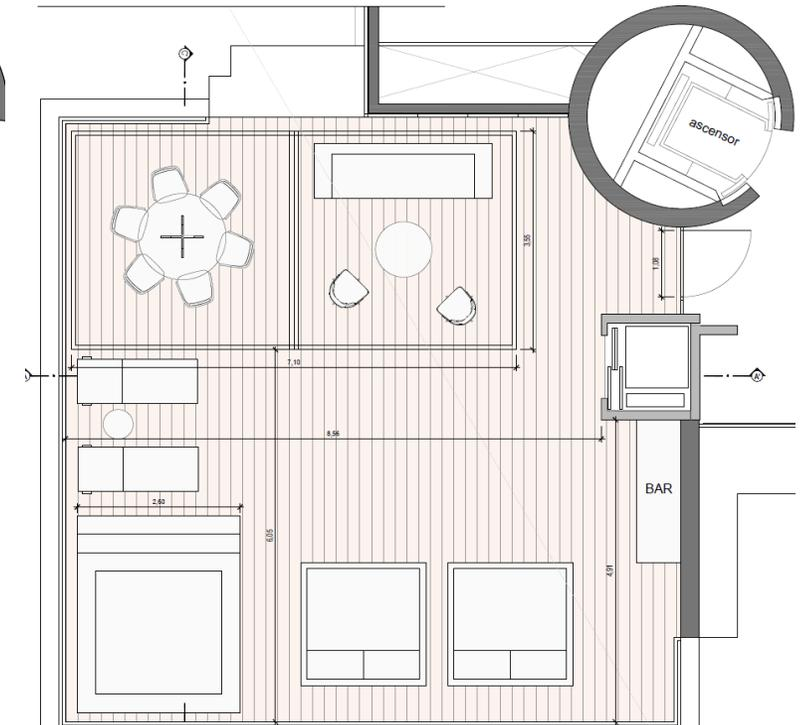

16th FLOOR



Red Level
PENTHOUSE SUITE
14th floor



Red Level
PENTHOUSE SUITE
15th floor





Red Level
PENTHOUSE SUITE
16th floor





Red Level Lounge

Red Level

LOUNGE

The most exclusive meeting point of Torre Melina.

Only for RedLevel members, this sophisticated lounge offers the chance to relax in front of the hotel's spectacular gardens, hold a meeting, work in your business area, or simply enjoy a coffee, tea, mixed drink, or premium drink, as well as sweet or savory snacks and the best tapas. Always, in the most distinguished and relaxed atmosphere.





F&B

F&B SPACES



Lobby

ERRE

Signature Restaurant by Iñigo Urrechu

CHROMA

Signature Cocktail Bar by Erik Lorincz

L'AMARANTA

All Day Dinning

Restaurant · Lobby Bar · Breakfast

—
Pool Area

BESO PEDRALBES

—
Pool Area

GALA TERRACE
POOL RESTAURANT

THE ART OF GRILLING



WINERY • GRILL
ERRE
& URRECHU

IÑIGO URRECHU

Signature restaurant

Led by grill master Íñigo Urrechú, ERRE is a steakhouse that pays the utmost care when choosing raw materials, giving priority to seasonal organic vegetables, wild fish and the most outstanding national and international meats.

In addition, ERRE offers the most select advice from our star sommelier, who will recommend the perfect pairing among more than 200 wines



CHROMA

Curated by Erik Lorincz



Winner of the 2010 Best Bartender of the Year Award and creator of the Kwant Restaurant in London, Erik Lorincz is one of the most talented and famous mixologists in the industry. With more than 20 years of experience, he is now bringing his flavours and creations to Barcelona, without losing any of the British savoir-faire.





L'AMARANTA

Lobby · Restaurant · Breakfast

The renovation of the lobby will offer these three elegant spaces bathed in light, ideal for admiring the hotel's gardens while savoring an uninterrupted gastronomic offer.

Enjoy breakfast, lunch or dinner in front of the beautiful nature that surrounds Torre Melina.

Amaranta can be a woman's name, a flower or a color similar to dark red or maroon. It means "she who will not wither", which leads us to a floral and garden concept that connects it with the space occupied by the restaurant.





B

BESO PEDRALBES

A gastronomic proposal based on Basque-Mediterranean cuisine that seeks inspiration in the sea and in the fire, the embrace between north and south, between land and sea.

Something magical, tasty and unique.

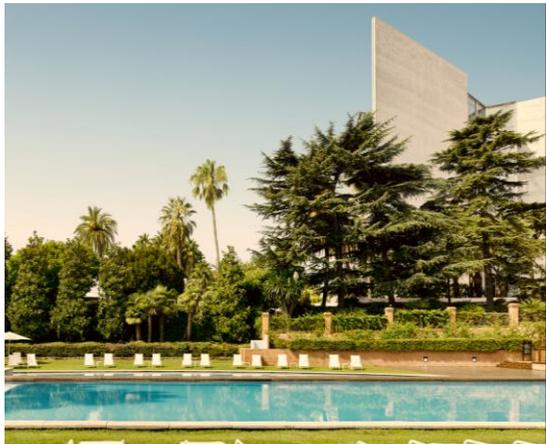

Let the day turn into night. Let yourself be surrounded by good music and the best atmosphere of Barcelona.



Gala

FOOD & DRINKS BY THE POOL

GRAN MELIÁ

Our GALA TERRACE POOL RESTAURANT has been to become the ideal urban getaway for those looking to enjoy the hedonistic pleasures of sun and summer.

Influenced by the magic of Dali's muse and the Mediterranean and designed with natural and sophisticated materials such as marble and oak wood, it is the perfect escape for a relaxed lunch by the pool.



A place reserved for only a few, where you can enjoy a luxurious menu influenced by the Mediterranean and bathed by the most exclusive products and ingredients.

Where you can enjoy a great celebration or an intimate party while listening to Mediterranean-inspired music mixed with the most contemporary lounge sound.

A place where the simplest things can become a work of art.

ROOFTOP



The top floor of Torre Melina will become the Rooftop of reference in Barcelona to celebrate private events.

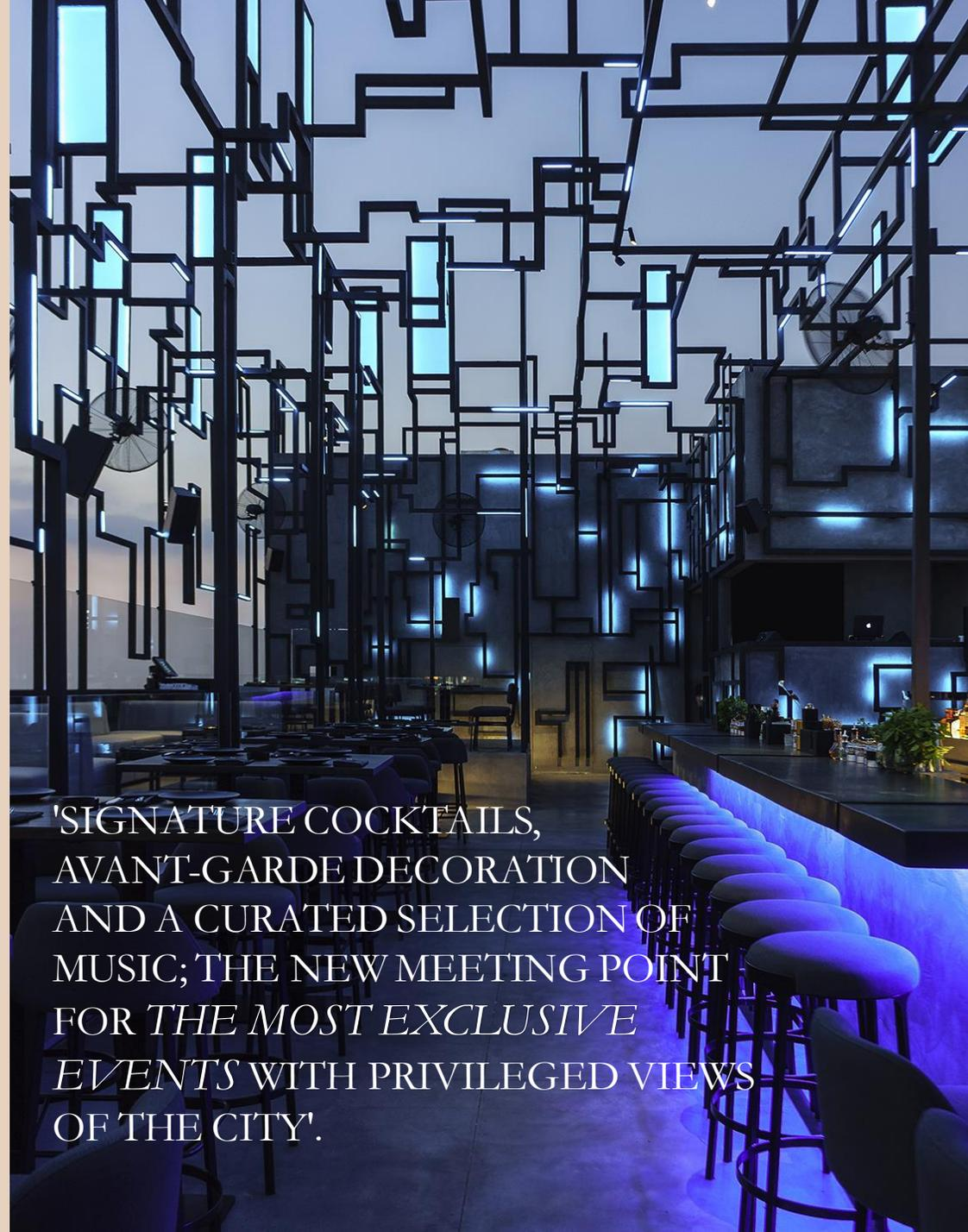

'SIGNATURE COCKTAILS, AVANT-GARDE DECORATION AND A CURATED SELECTION OF MUSIC; THE NEW MEETING POINT FOR THE MOST EXCLUSIVE EVENTS WITH PRIVILEGED VIEWS OF THE CITY'.



Gardens

In the bustle of the majestic city of Barcelona, being surrounded by nature, silence and tranquility can become the closest idea of paradise on earth.

Gardens and lush green areas designed by **Josep Fontserè i Mestre**, and inspired by the large romantic gardens of the 19th century, make up an **idyllic place to disconnect in the noble neighborhood of Pedralbes**.

Among the gardens, there is a modernist farmhouse, **Torre Melina**, which helps us evoke the Barcelona of the beginning of the 20th century: a cosmopolitan and vibrant city that inspired travelers, writers and great artists.





Wellness

We will provide a wellness experience
where body and mind are cared for
equally.



*Meeting
Rooms*

TORRE MELINA - MEETING ROOMS



The hotel counts with 17 meeting rooms. Each of them is equipped with the best technology to adapt the needs of every client. Spaces are ideal for meetings, presentations and business conferences.

All meeting rooms have day light, are located inside the hotel and offer everything to hold a meeting in a quiet and elegant space.

TORRE MELINA - MEETING ROOMS

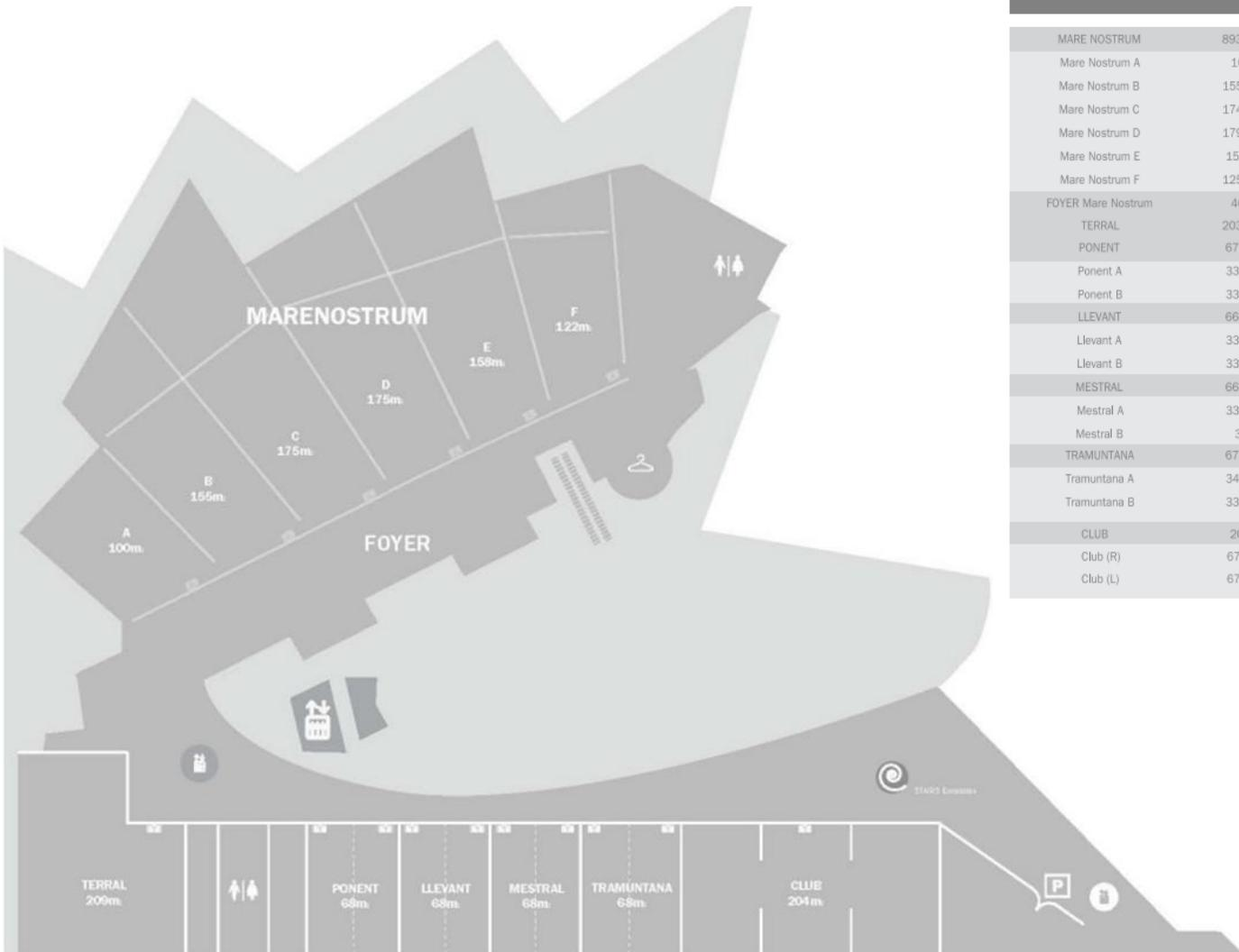

MEETING ROOM	SQ.M.	SQ.FT	Height(m)	Length(m)	Width(m)	Banquet	Cocktail	*U*Shape	Cabaret	School	Theater
MARE NOSTRUM	893,26	9,611,45	4	irregular	irregular	620	886	N/S	488	500	886
Mare Nostrum A	100	1,076	4	irregular	irregular	60	80	36	48	45	80
Mare Nostrum B	155,09	1,668,76	4	irregular	irregular	110	130	42	72	72	132
Mare Nostrum C	174,68	1,879,55	4	irregular	irregular	120	150	42	104	96	174
Mare Nostrum D	179,94	1,936,15	4	irregular	irregular	130	150	42	104	120	180
Mare Nostrum E	158,3	1,703,3	4	irregular	irregular	110	150	42	88	108	160
Mare Nostrum F	125,25	1,347,69	4	irregular	irregular	90	100	42	72	60	100
FOYER Mare Nostrum	467	5,049,34	2,5	irregular	irregular	N/A	300	N/A	N/A	N/A	N/A
TERRAL	203,12	2,185,57	2,48	17,59	14,95	140	150	34	64	48	100
PONENT	67,09	721,87	-	-	-	40	40	24	32	24	40
Ponent A	33,63	361,85	2,36	8,6	4,05	20	20	15	16	16	25
Ponent B	33,46	360,02	2,36	8,6	4,05	20	20	15	16	16	25
LLEVANT	66,96	718,47	2,36			40	40	24	32	24	40
Llevant A	33,43	359,7	2,36	8,6	4,05	20	20	15	16	16	25
Llevant B	33,53	358,77	2,36	8,6	4,05	20	20	15	16	16	25
MESTRAL	66,21	708,77	2,36			40	40	24	32	24	40
Mestral A	33,21	355,67	2,36	8,6	4,05	20	20	15	16	16	25
Mestral B	33	353,1	2,36	8,6	4,05	20	20	15	16	16	25
TRAMUNTANA	67,48	785,48	2,36			40	40	24	32	24	40
Tramuntana A	34,29	430,4	2,36	8,6	4,05	20	20	15	16	16	25
Tramuntana B	33,19	355,08	2,36	8,6	4,05	20	20	15	16	16	25
CLUB	204	2,194,94					100	N/A	N/A	N/A	N/A
Club (R)	67,08	721,78	2,37	8,7	7,8	N/A	N/A	18	N/A	N/A	N/A
Club (L)	67,99	731,57	2,37	8,7	7,75	30	30	24	24	24	40



PALAU DE CONGRESSOS DE CATALUNYA BARCELONA

MANAGED BY MELIÀ HOTELS INTERNATIONAL





PALAU DE CONGRESSOS DE CATALUNYA

'A SYMBOL OF THE MOST CONTEMPORARY BARCELONA'

It's located on the prestigious Diagonal Avenue in Barcelona, the most important financial and commercial avenue of the city.

The building is surrounded by one of the most beautiful gardens of the city, and its structure is made up of different assembled buildings that highlight the modular design that characterizes it.

The main protagonist is the natural light that invades its multiple rooms. The beauty, harmony and simplicity of its lines is complemented by the great functionality and versatility of its spaces. It has a total of 39 rooms of different sizes. Its auditorium has a capacity for more than 2.000 people and counts on exhibition spaces of more than 4.000 sqm.





01

DIAGONAL LEVEL



STRUCTURE

The grand entrance to the building with its spectacular **Hall**, **Foyer**, an incomparable **Auditorium** and an **Exhibition Area** are the venues that make up the Diagonal Level of the Palau de Congressos de Catalunya

Wide and elegant spaces with harmonious proportions are integrated into the splendid architecture of the Palau, maintaining its own personality. Venues with different purposes and perfectly equipped with the latest technology are designed to facilitate the celebration and success of all kinds of national and international events.



1.1 ENTRANCE & MAIN HALL

The main access to the Palau de Congressos de Catalunya is found at Diagonal Avenue. A spectacular Hall of wide dimensions and great luminosity is the best way to welcome all the participants of the multiple acts and events that take place. It has a reception for events and a large cloakroom

	ENTRANCE
SURFACE (sqm)	460,00

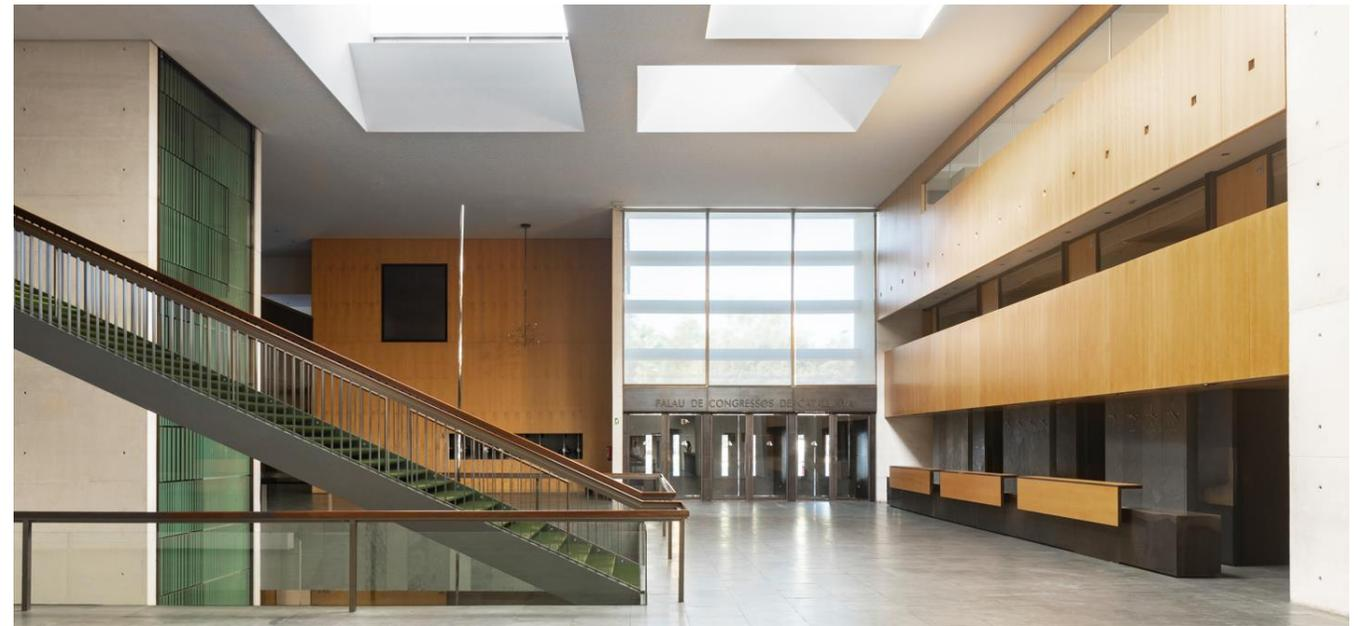



1.2 AUDITORIUM

Definitely one of the jewels of the Palau.

Its capacity and high technology are calculated to the smallest detail, prioritizing the essential requirements in this type of space.

It's divided into two levels: the Platea and the Amphitheatre, together with the boxes. The acoustics of the room are perfectly clear from any point, without resonances or echoes, and the visibility of the stage is complete.

With a total capacity for 1.897 people, it is equipped with exclusively designed seats, work tables, computer connections and power outlets.

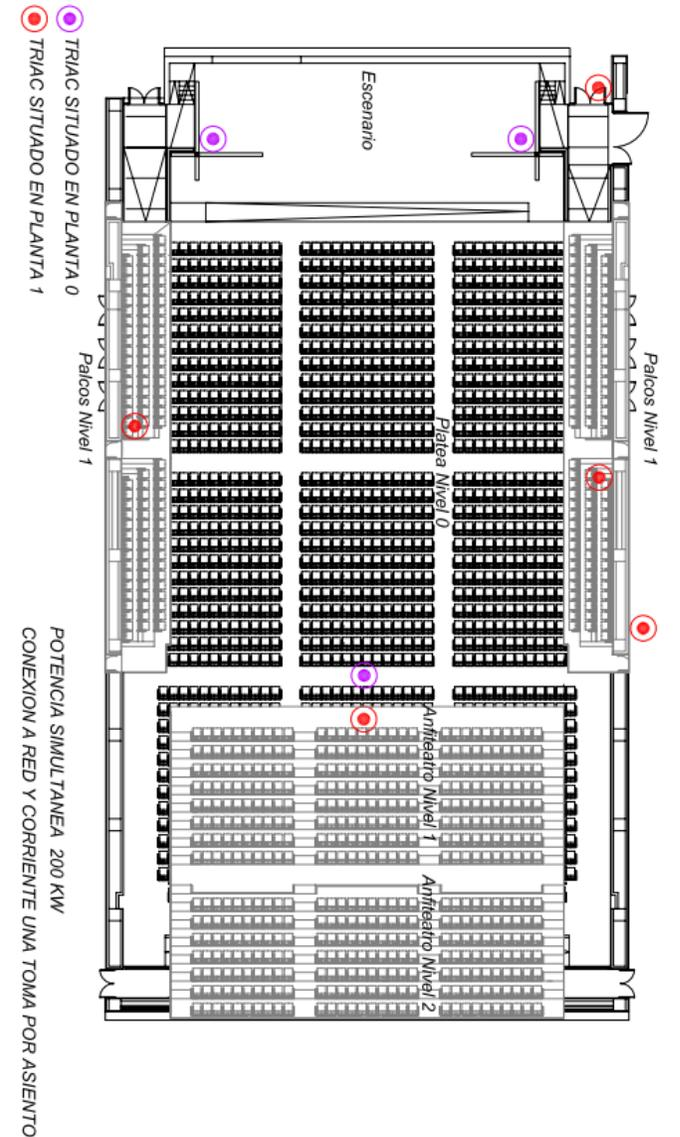
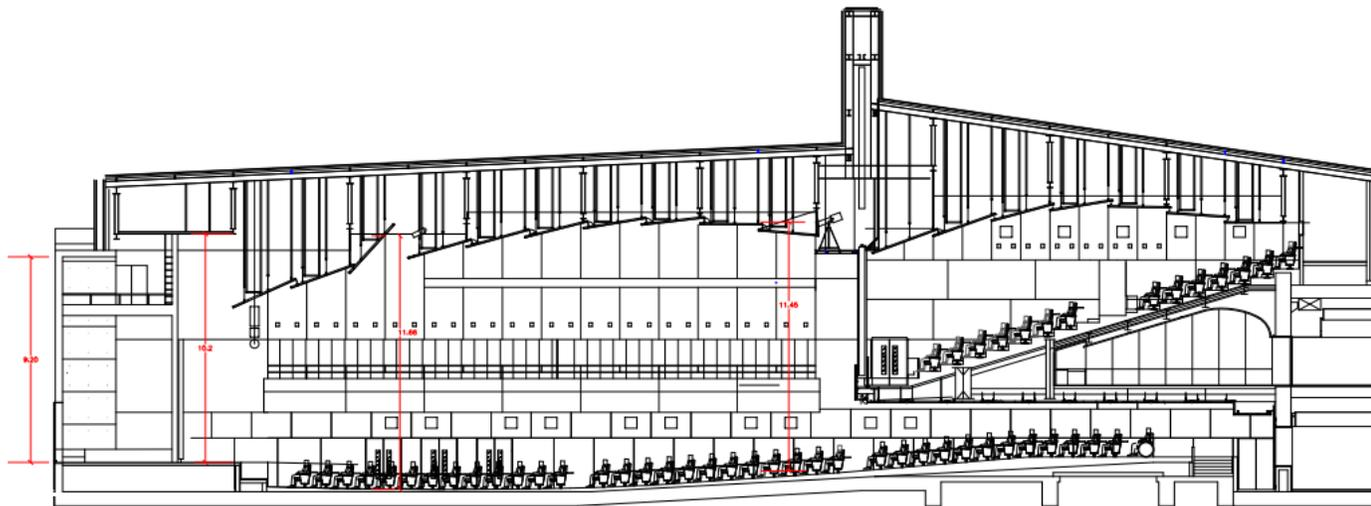



1.2 AUDITORIUM

The Auditorium has state-of-the-art audiovisual material as well as a large stage that can be accessed via a ramp or from both sides and a fabulous lead screen of 18,00x 5,50 meters

CAPACITY	PLATEA	AMPHITHEATRE	BOXES
THEATRE	1369 (925 hasta cortina)	450	208 (104 cada uno)
SCHOOL	1369 (925 hasta cortina)	450	208 (104 cada uno)

ROOM	NETWORK CONNECTIONS	TRIAx	POWER SUPPLIERS	SIMULTANEO US POWER
STAGE		2		200 KW
STALLS & BOXES	1 per seat	5	1 per seat	
AMPHITHEATRE	1 per seat	1	1 per seat	





1.3 DIAGONAL FOYER

One of the most beautiful public areas of the complex, thanks to its spectacular stained glass windows that show the beauty of the gardens and the lake of Torre Melina.

It's divided in two levels and connected by a wide staircase.

An ideal space for cocktails, coffee breaks, lounge area, exhibitions and others.

CAPACITY	FOYER 0		FOYER 0
BANQUET	150	HEIGHT	4,00
COCKTAIL	250	SURFACE	420

SALA	CONEXIONES A RED (Datos y telefonía)	TRIAx	POTENCIA SALA KW
FOYER 0	25		3,3

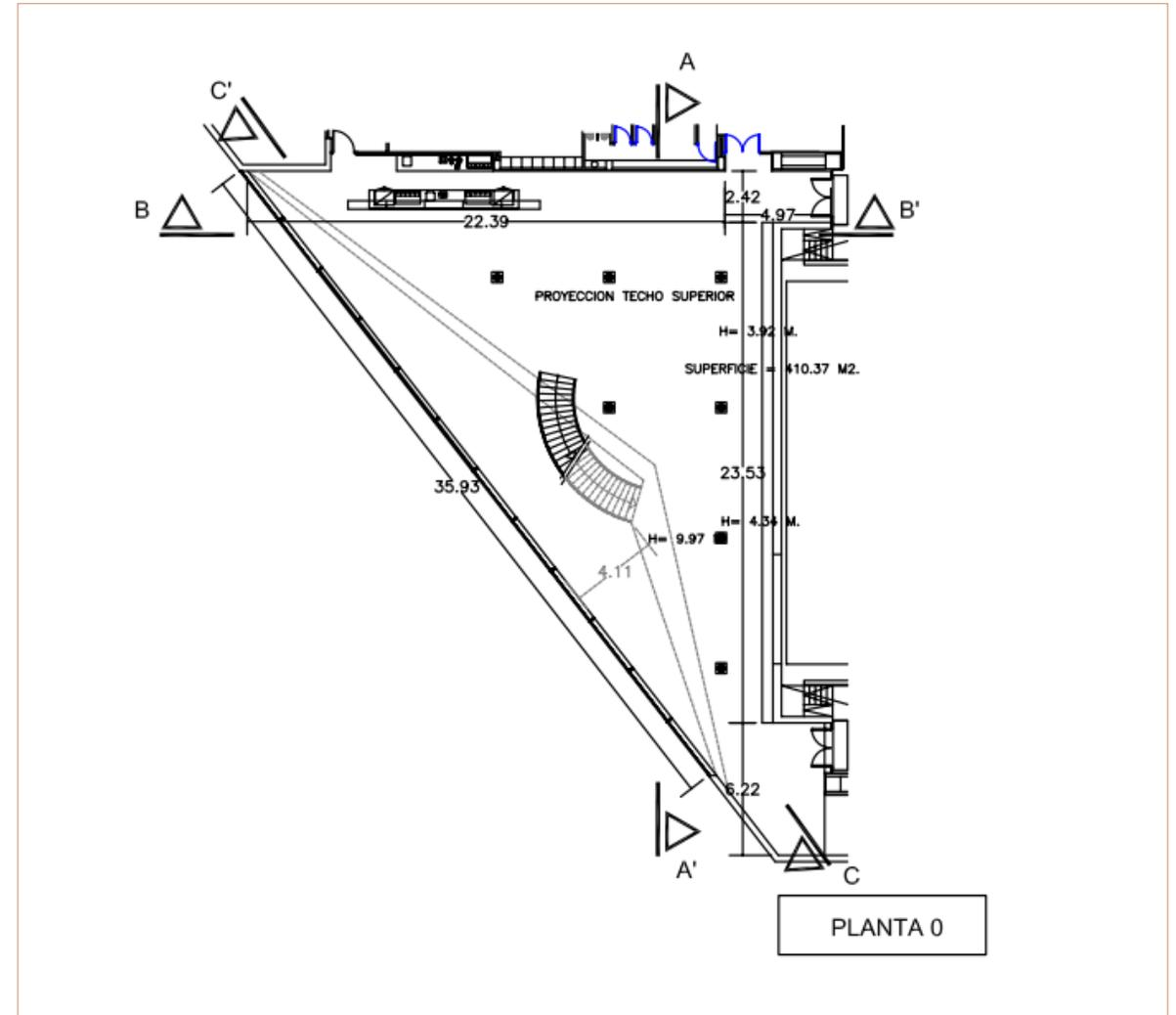



1.3 DIAGONAL FOYER





1.4 SHOWROOM | EXHIBITION HALL

A large space of 1,783.48m² and 6.90 meters high that stands out for its great natural light and spectacular views of the gardens and Avenida Diagonal.

In addition, it can be divided in two rooms, built with direct access for forklifts in order to provide the loading in a comfortable and operational way.

The Exhibition Hall is an incomparable setting where you can enjoy large gala dinners, award ceremonies, commercial exhibitions, presentations and fashion shows, and others.

SALAS	CONEXIONES A RED (Datos y telefonía)	TRIAx	POTENCIA SIMULTANEA
EXPO I	48	2	160 KW
EXPO II	144	2	

	EXPO I	EXPO II	EXPO COMPLETA
DIMENSIONES	20,83 X 19,76	55,03 X 24,45	75,86 X 24,45 / 19,76
HEIGHT	6,90	6,90	6,90
SURFACE	438	1.345,48	1.783,48

CAPACIDAD	EXPO I	EXPO II	EXPO COMPLETA
THEATER	390	1.600	2.126
SCHOOL	250	954	1.341
BANQUET	300	1.020	1.584
COCKTAIL	400	1.500	2.000

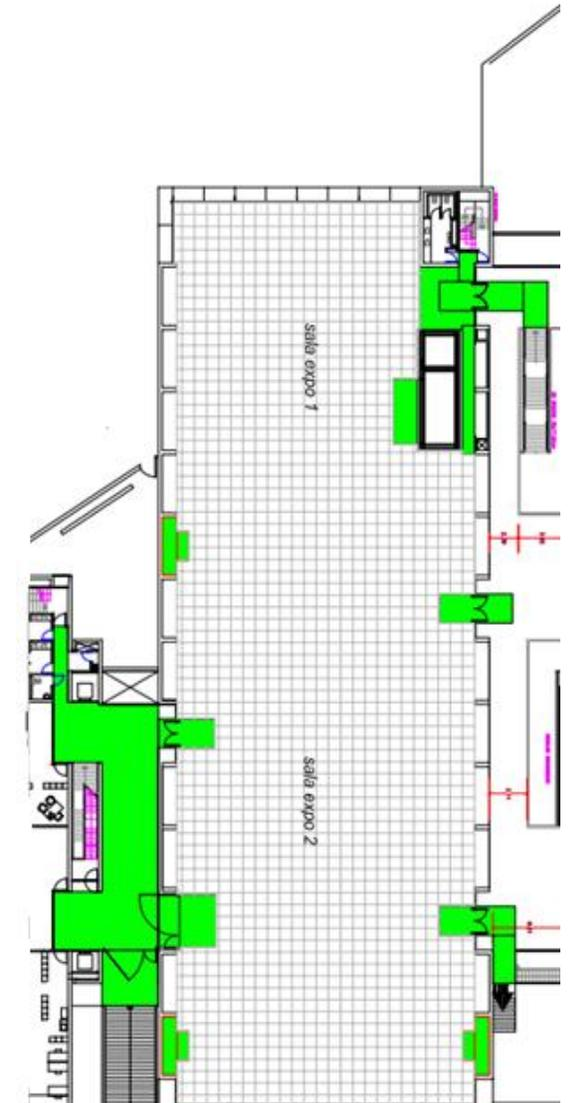



1.4 SHOWROOM | EXHIBITION HALL





02

GARDEN LEVEL



C/Torre Melina

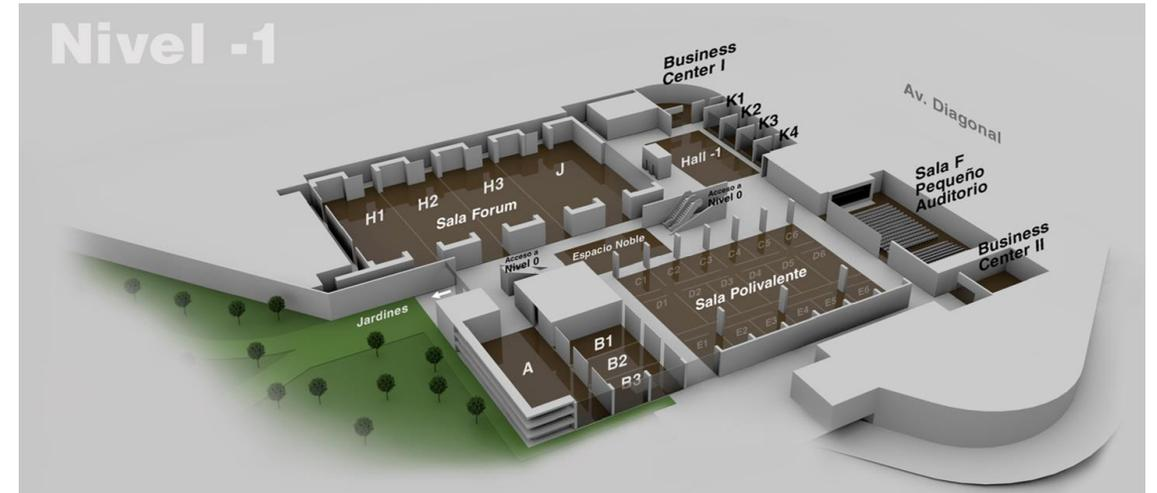

STRUCTURE

This floor stands out for the functionality and versatility of its large meeting rooms, which can be modulated and adapted according to the needs of the clients.

The most outstanding areas are the Polyvalent Room and the Forum Room, which occupy practically the entire floor. The Hall is also a relevant space, open and with natural light, which is suitable for holding exhibitions, cocktails and coffee breaks. Various meeting and conference rooms, as well as two Business Centers, complete the offer.



2.1 FORUM ROOM

CAPACITY	H1, H2, H3	J
THEATRE	280	456
SCHOOL	156	294
BANQUET	216	360
COCKTAIL	250	380
U SHAPE	60	78

	H1, H2, H3	J
DIMENSIONS	10,40 x 27,58	16,46 x 27,58
HEIGHT	4,00 – 4,35	4,00 – 4,35
SURFACE	270,72 m ² (por unidad)	428m ²



It is made up of four modular rooms, which can be paneled independently or combined, creating spaces of different sizes. The room has an area of 1,240.16 sqm and a maximum capacity of 1.480 people.

COMBINATIONS	SURFACE	THEATRE	SCHOOL	BANQUET	COCKTAIL	U SHAPE
H1 + H2 / H2 + H3	541,44	546	330	432	500	93
H1 + H2 + H3	812,16	800	540	648	800	123
H3 + J	698,72	756	420	576	600	102
H1 + H2 + H3 + J	1240,16	1480	840	1008	1100	207



2.2 POLYVALENT ROOM

This room stands out for its versatility and functionality.

With a total surface of 1,084 sqm, it can be divided into 18 rooms that can be combined with each other, making it the ideal space to hold anything from small meetings to large banquets or exhibitions

CAPACITY	Cs	Ds	Es
THEATRE	20	42	30
SCHOOL	12	30	18
BANQUET	20	30	20
COCKTAIL	15	30	20
U SHAPE	12	24	12

ROOMS	NETWORK CONNECTIONS	TRIAx	ROOM POWER KW
Cs	4	no	9 (6 en C6)
D1 - D4	6	no	12
D5 - D6	12	no	12 (9 en D6)
E1 - E4	6	no	9
E5 - E6	10	no	9

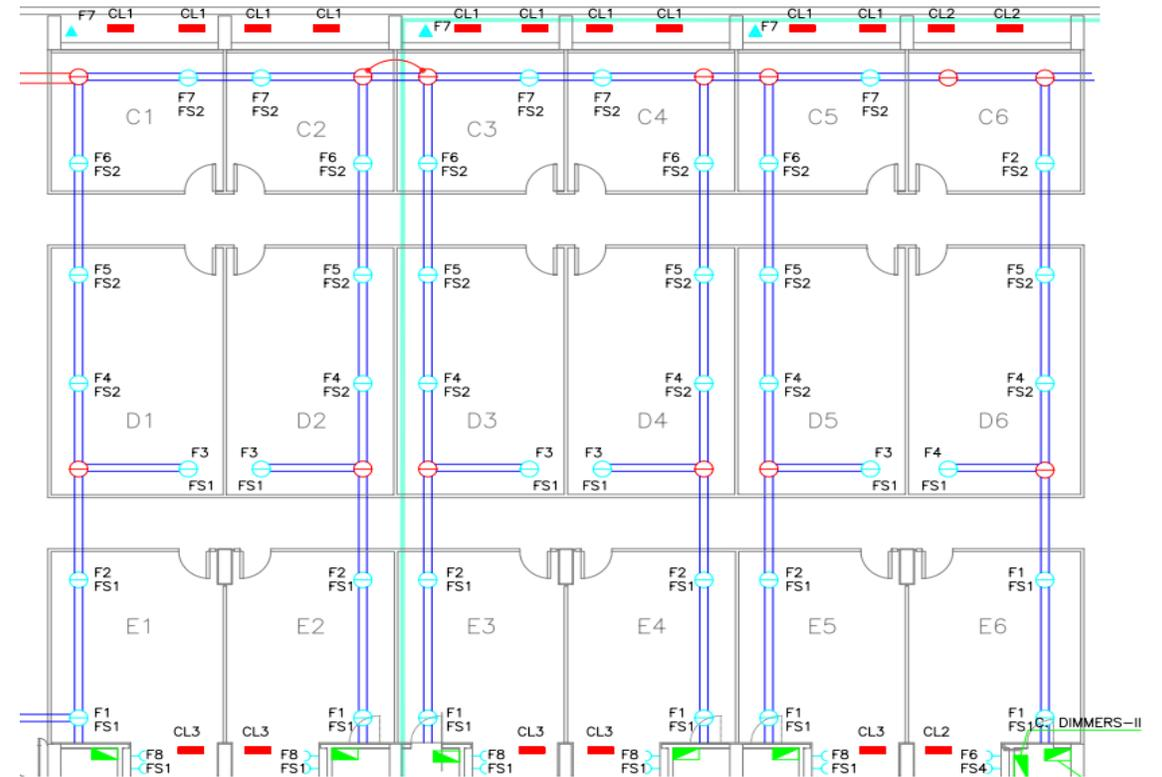

	C1	C2	C3	C4	C5	C6
SURFACE (m²)	25,84	25,11	25,11	25,11	25,11	25,84
	D1	D2	D3	D4	D5	D6
	46,00	44,70	44,70	44,70	44,70	46,00
	E1	E2	E3	E4	E5	E6
	38,80	37,96	37,96	37,96	37,96	38,80



2.2 POLYVALENT ROOM

COMBINATIONS	SURFACE (sqm)	HEIGH (M)	THEATRE	SCHOOLA	BANQUET	COCKTAIL	U SHAPE
C1+C2 / C5 + C6	50,95	3,60 - 3,95	40	24	20	50	27
C2 + C3 / C3 + C4 / C4 + C5	50,22	3,60 - 3,95	40	24	20	50	27
C1+C2+C3/C4+C5+C6	76,06	3,60 - 3,95	60	36	60	60	39
C2+C3+C4/C3+C4+C5	75,33	3,60 - 3,95	60	36	60	60	39
D1+D2 / D5 + D6	90,70	3,60 - 3,95	104	48	40	80	36
D2 + D3 / D3 + D4 / D4 + D5	89,40	3,60 - 3,95	104	48	40	80	36
D1+D2+D3/D4+D5+D6	135,40	3,60 - 3,95	170	80	90	100	48
D2+D3+D4/D3+D4+D5	134,10	3,60 - 3,95	170	80	90	100	48
E1+E2 / E5 + E6	76,76	3,60 - 3,95	72	36	40	50	30
E2 + E3 / E3 + E4 / E4 + E5	75,92	3,60 - 3,95	72	36	40	50	30
E1+E2+E3/E4+E5+E6	114,72	3,60 - 3,95	115	54	60	90	48
E2+E3+E4/E3+E4+E5	113,88	3,60 - 3,95	115	54	60	90	48
POLYVALENT ROOM	1058,00	3,60 - 3,95			800	1000	





2.3 ROOMS "A" + "B"

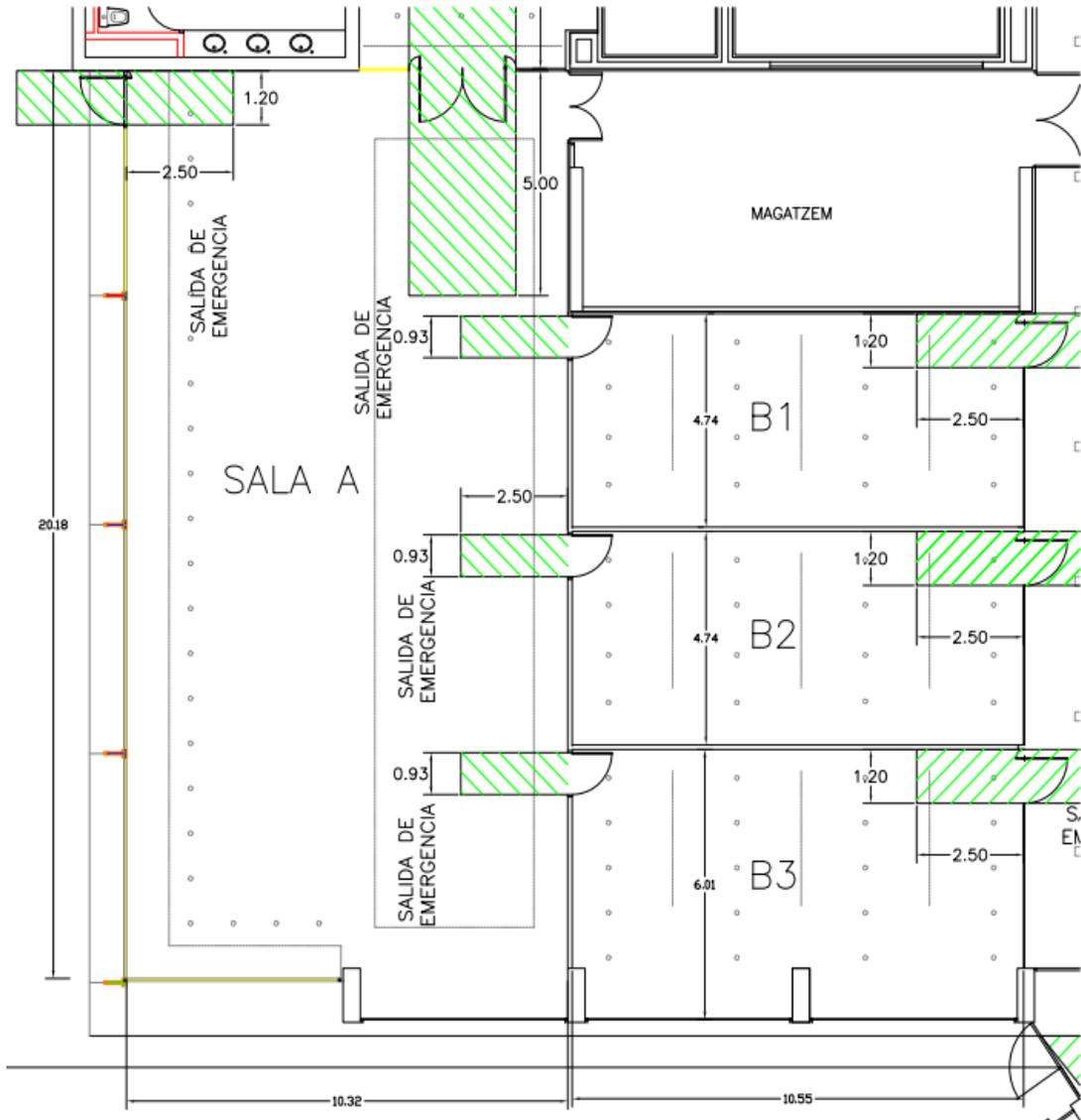

Room a is one of the most beautiful spaces in the palau. The large windows that surround it offer views of the complex's romantic gardens and the natural light that filters through them recreates a warm and relaxing space. The total area of its 212m² is perfect for holding cocktails, appetizers, meetings or exhibitions

Rooms b are three modular spaces that can be combined with each other to organize small meetings and conferences. Both room a and rooms b can be converted into a single 374m² space, preserving the magnificent views of the gardens and natural light.

CAPACITY	A	B1, B2, B3
THEATRE	200	45
SCHOOL	120	30
BANQUET	140	30
COCKTAIL	200	45
U SHAPE	45	27

	A	B1	B2	B3
DIMENSIONS	10,32 x 20,17	10,55 x 4,74	10,55 x 4,74	10,55 x 5,89
HEIGHT	3,60 - 3,95	3,6	3,6	3,6
SURFACE	208,15	50	50	62,14



2.4 BUSINESS CENTER | AND |

	BCI	BCII
DIMENSIONS	Ver plano	9,28 X 7,13
HEIGHT	3,57	1,95 - 3,60
SURFACE	104,43	66

CAPACITY	BC I	BCII
THEATRE	40	24
SCHOOL	24	18
BANQUET	30	30
COCKTAIL	40	40
U SHAPE	20	15

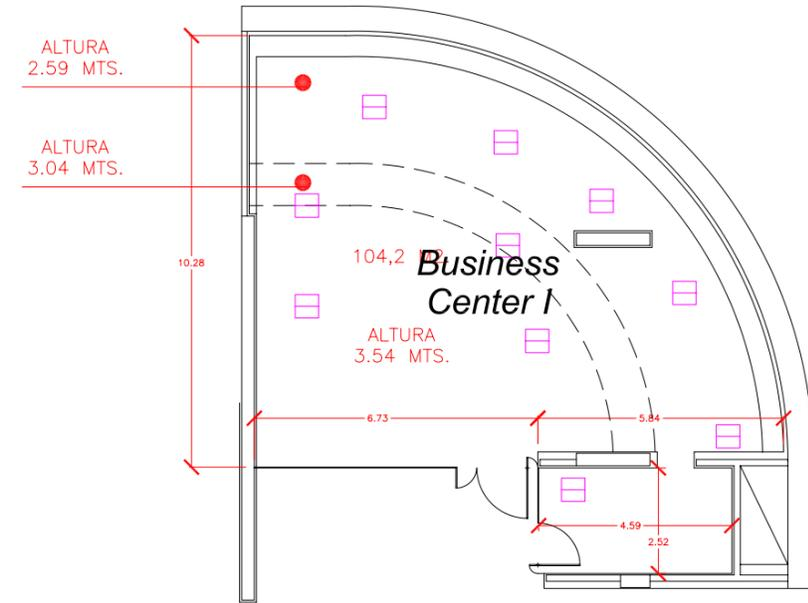

ROOMS	NETWORK CONNECTIONS	TRIAx	ROOM POWER KW
BCI	27	NO	9
BCII	19	NO	6

Level -1 has two business centers, business center i is ideal for installing the executive headquarters of the event.



2.5 ROOMS "K"



	K1	K2	K3	K4
DIMENSIONS	5,85 X 4,64	5,85 X 4,61	5,52 X 4,61	5,52 X 4,56
HEIGHT	3,00	3,00	3,00	3,00
SURFACE	27,12	26,95	25,42	25,2

ROOMS	NETWORK CONNECTIOS	TRIAX	ROOM POWER KW
K1	8	NO	6
K2	10	NO	6
K3	10	NO	6
K4	10	NO	6

CAPACITIES	KS
THEATRE	15
SCHOOL	12
BANQUET	10
COCKTAIL	15
U SHAPE	9

This group of small rooms is made up of four 26m² offices, being the appropriate space to hold small meetings

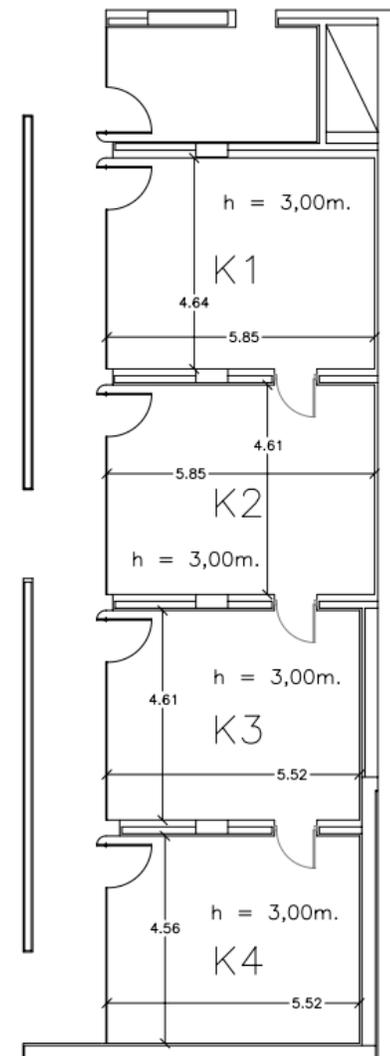



2.7 “NOBLE SPACE” AND “HALL”

The Hall space and the adjoining Noble Spaces are the perfect setting for holding cocktails, coffee breaks and exhibitions.

	HALL -1	NOBLE SPACE
SURFACE m ²	657,51	1037,25

ROOMS	NETWORK CONNECTIONS	TRIAX	ROOM POWER KW
HALL - 1		2	

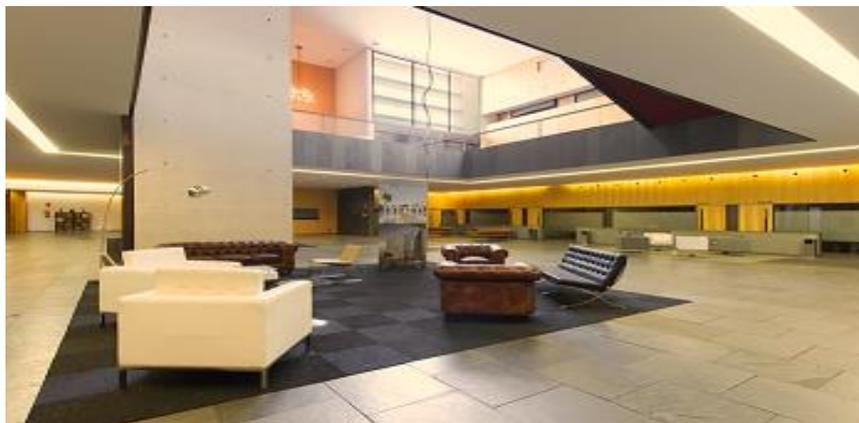
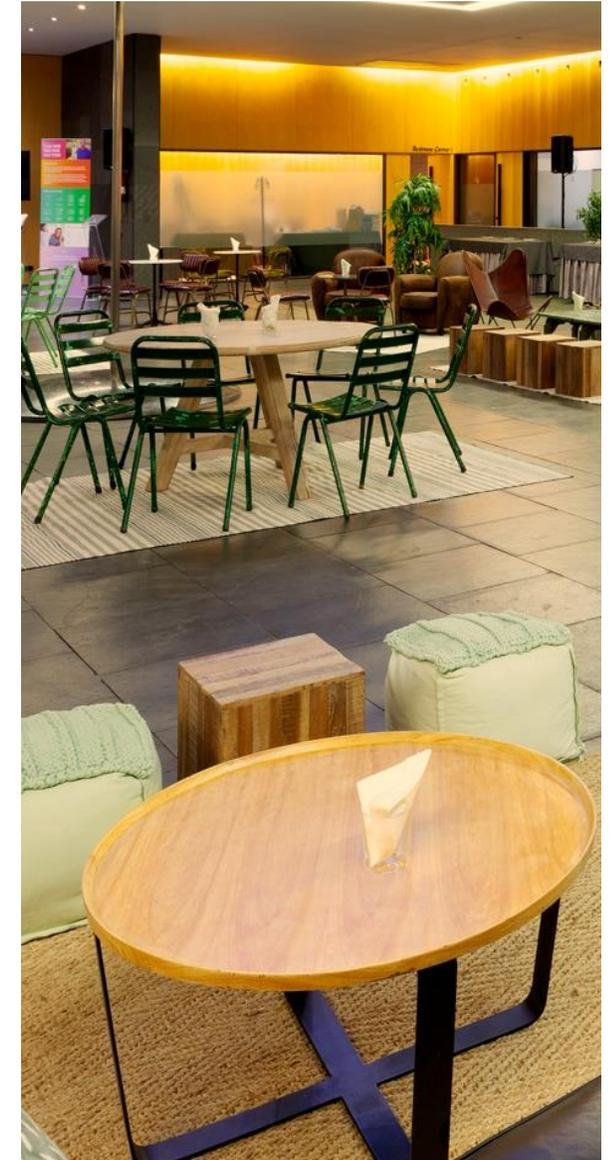



2.8 "GARDEN" ROOM





2.8 "GARDEN" ROOM





**PALAU DE CONGRESSOS
DE CATALUNYA BARCELONA**

MANAGED BY MELIÀ HOTELS INTERNATIONAL

Palau de Congressos de Catalunya
Av. Diagonal, 661 – 671
08028 Barcelona (Espanya)

PALAU DE CONGRESSOS
DE CATALUNYA